

### CONFIGURAZIONE / CONFIGURATION / KONFIGURATION

Descrizione meccanismo	Mechanism description	Getriebebeschreibung	RIG06 8-310 VLRA VCM DA
Legge di moto	Motion law	Bewegungsgesetz	8-310 (Ca=5.528)
N° cicli	Number of cycles	Anzahl der Schaltzyklen	1
Versione uscita	Output version	Ausführung Schalttisch	VCM
Piano albero entrata	Input shaft projection	Seite mit Antriebswelle	DA
Predisposizione riduttore	Gearbox pre-arrangement	Einrichtung für Getriebe	40/F1 LCB
Posizione riduttore	Gearbox position	Anbaulage des Getriebes	S2
Forature sul piano superiore della scatola	Holes on the housing upper plane	Gewindebohrungen in der Gehäuseoberseite	No
Forature opzionali di riferimento	Optional reference holes	Optionale Stiftlochbohrungen	Yes

### RIDUTTORE / GEAR UNIT / GETRIEBE

Descrizione riduttore	Gear unit description	Getriebebezeichnung	RMI 40/F1 LCB
Predisposizione motore	Preset for IEC motor	Verbindungen mit IEC-Motor	71B14
Rapporto riduzione	Gearbox reduction ratio	Getriebeübersetzung	1:10
Taratura	Adjustment	Auslösemoment	46.0 Nm
Codice riduttore	Gear unit code	Getriebe-code	3101721

### MOTORE / MOTOR / MOTOR

Descrizione motore	Motor description	Motorenbeschreibung	BA71C4B14
Freno	Brake	Bremse	Yes
Tensione e Frequenza	Voltage and Frequency	Spannung und Frequenz	230/400V 50Hz - 277/480V 60Hz
Potenza	Power	Leistung	0.55 kW
Codice motore	Motor code	Motor Code	3106550

### MICRO / MICRO / ENDSCHALTER

Tipo gruppo micro	Micro assembly type	Typ der Endschalterbaugruppe	MID
Versione micro	Micro version	Version der Endschalterbaugruppe	Full

A

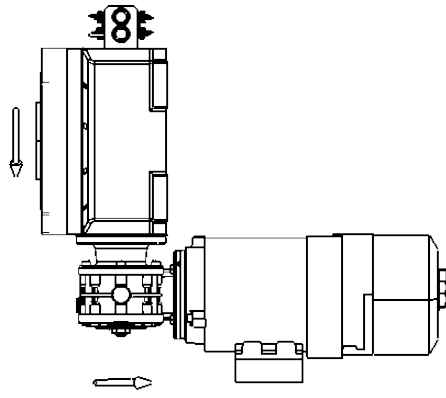

B

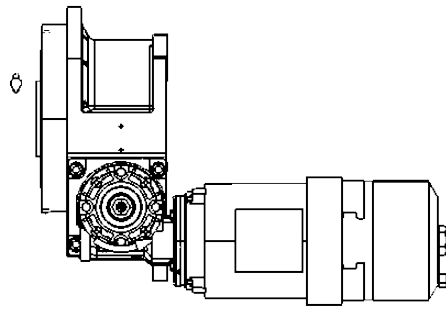

C

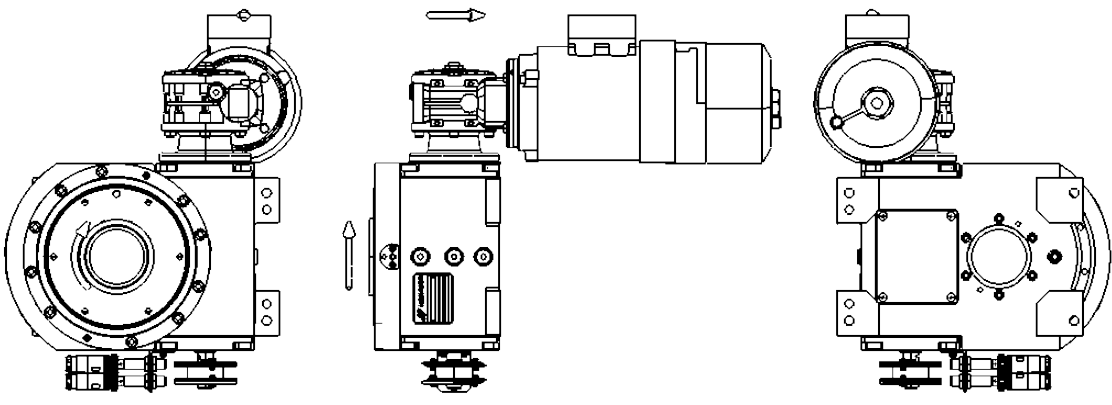

D

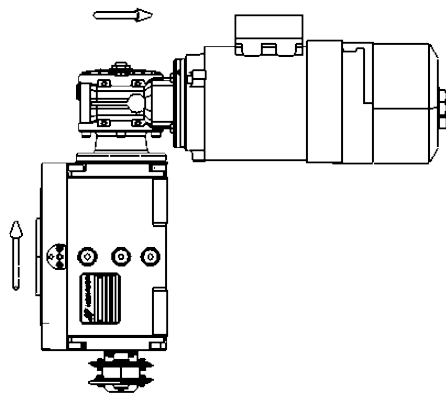

E

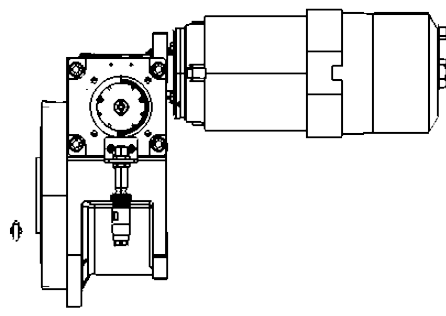

F PC5101689

Le dimensioni del singolo meccanismo RIG, corrispondono all'ultima versione del catalogo disponibile sul sito [www.cofil.it](http://www.cofil.it)  
 The dimensions of the single RIG mechanism, correspond to the latest version of the catalogue available on the website [www.cofil.com](http://www.cofil.com)  
 Die Abmessungen des einzelnen RIG-Mechanismus, entsprechen der neuesten Version des Katalogs der auf der Website [www.cofil.com](http://www.cofil.com) verfügbar ist

	Date	Name
Draw	20/05/2026	L. C.
	Scale	Sheet
	1:9	1/1



**COLOMBO FILIPPETTI SPA**  
 I-24040 Casirate d'Adda  
[www.cofil.com](http://www.cofil.com)  
 PROPERTY RESERVED

Code	PC5202071
Description	RIG06 8-310 VLRA VCM DA F 40/F1 LCB